



B 36 MECHANICAL REBAR BENDING MACHINE OPERATING & MAINTENANCE MANUAL



GÖÇMAKSAN

Rev:01/2013

CONTENTS

CONTENTS	1
LIST OF FIGURES	2
TAGS USED ON THE MACHINE.....	3
INTRODUCTION	4
1. MAIN PARTS OF BENDING MACHINE	4
2. MACHINE ASSEMBLY.....	5
3. MACHINE RUNNING PROCEDURES ORDER.....	6
4. TECHNICAL DATA.....	7
5. EQUIPMENT SUPPLIED WITH MACHINE.....	7
6. USING THE MACHINE	8
6.1 Correct Connection of the Irons on the machine	8
6.2. Incorrect placement of the irons to be bent on the machine	8
6.3. Incorrect placement of the irons to be bent on the machine	9
7. PROHIBITED USAGE ON THE MACHINE	10
8. SCOPE OF THE WARRANTY	11
9. PROTECTORS TO BE USED WHEN WORKING WITH THE MACHINE	11
9.1. Protector apparel	11
9.2. Work clothes	12
10. HANDLING THE MACHINE	12
11. CONTROLS AND SETTINGS ON THE MACHINE.....	13
11.1. Thermal flow setting range and motor protection switch	14
11.2. Bent Bar Bending setting (45°).....	15
11.3. Protractor Bending Setting (90°)	16
11.4. Hook Bending Settings (180°).....	17
11.5. Stirrup Bending:.....	17
12. MAINTENANCE AND LUBRICATION INSTRUCTIONS.....	20
10. FAULTS AND SOLUTION OFFERS	20
14. MACHINE EQUIPMENT LIST	23
15. MACHINE ASSEMBLY.....	25
16. MACHINE ELECTRICITY SCHEME.....	26
17. ABOUT COMPANY	28









LIST OF FIGURES

Figure 1: Main parts of bending machine	4
Figure 2: Leveling the machine on a solid ground.....	5
Figure 3: Control buttons	6
Figure 4: Placing the irons on the machine correctly.....	8
Figure 5: Incorrect connection of the irons on the machine	9
Figure 6: Wrong placement of the irons on the machine	10
Figure 7: Wrong positioning of the person making bend	10
Figure 8: Handling the machine.....	13
Figure 9: Machine control panel and functions	13
Figure10: Bent bar bending indicator	16
Figure 11:Representation of Protector Bending.....	16
Figure12: Hook Bending demo.....	17
Figure13: Stirrup bending demo	19

MAIN SAFETY INFORMATION

- This symbol is put before the articles giving warning explanations in order to draw attention of the trained operator to important functions.
- € This symbol is put before the articles giving warning explanations in order to draw attention of the trained operator to electrical issues.
-  This symbol is put before the sentences in order to draw attention of the trained operator to the master instructions and directive regarding to handling or safety.

TAGS USED ON THE MACHINE

	Trademark plate of manufacturer company
	Logo plate of manufacturer company
B 36	Model name tag of the machine
	CE norm conformity tag
	Plate on capacity and technical information of the machine
	Machine user's and maintenance manual tag
	Handling and carrying hook tag
	Electricity panel warning tag
	Grounding output tag

INTRODUCTION

B 36 Mechanic Iron Bending Machine is made only with the purpose of steel material bending. Using other than the indicated purposes are prohibited. It is possible to mount various apparatuses on the machine optionally for bending in different shapes.

In order to obtain the best yield from the machine it should be in a situation so that it can be worked easily and in a position that more productivity might be obtained from the operator. Because of this the location where the machine is operated should be close to the iron stocks. Besides, it shall be more useful to cover top of the location where the machine is operated with a shelter. We suggest two workbenches to be located on two sides of the machine. Length of these workbenches should be as long as the longest iron that will be bent. Since the operator will be able to work without turning, lifting any kind of iron, it will enable the operator to work more effectively.



Important Warning !!!

- User's and maintenance manuals must be read.
- Machine should be operated by instructed workers.
- When adjustments such as controlling, maintaining, lubing are being made electricity of the machine must be cut off.
- All of the explanations given under user's and maintenance manual must be complied.

1. MAIN PARTS OF BENDING MACHINE

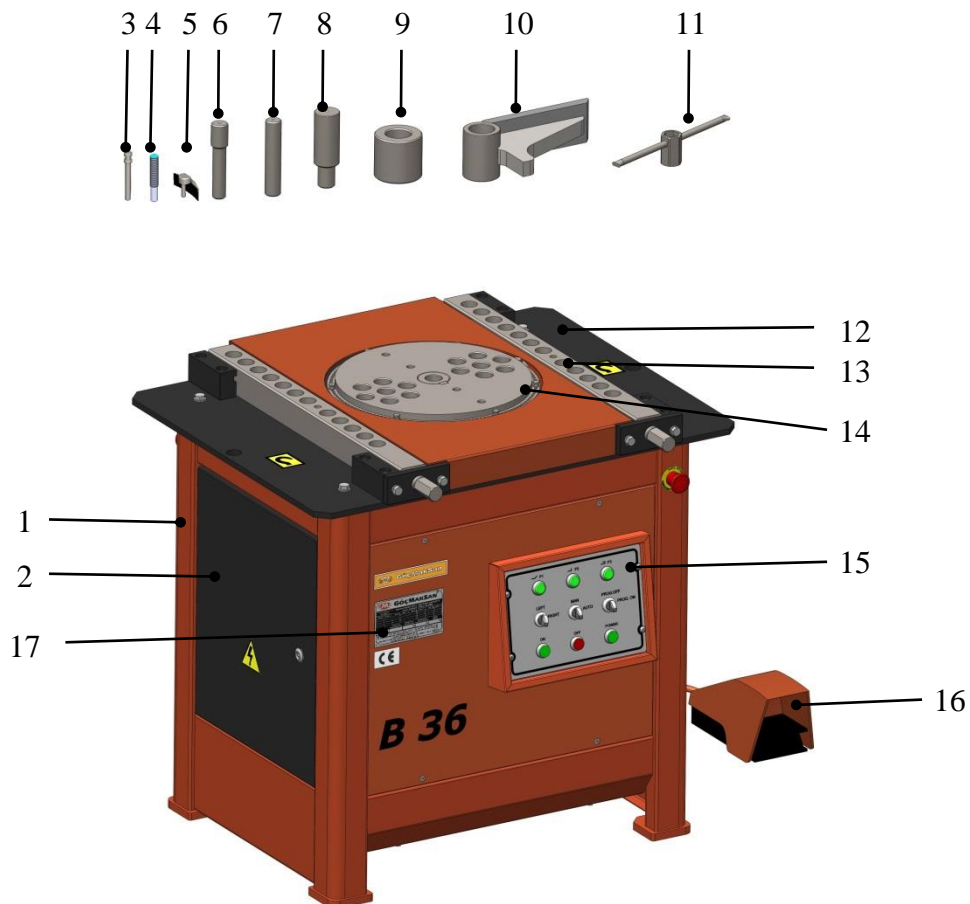

Figure 1: Main parts of bending machine

1	Machine Frame	5	Zero Adjustment Pin	9	Bending Sleeve	13	Bending Plates
2	Electricity Board Cap	6	Stirrup Pin	10	Retainer	14	Bending Flange
3	Switch Adjustment Pin	7	Straight Pin	11	Adjustment spanner	15	Control Panel
4	Sensor Pin	8	Bending Pin	12	Machine Table	16	Foot Pedal
17	Plate						

2. MACHINE ASSEMBLY

- Machine should be leveled on a solid ground. **Figure 2**
- Electricity connection of the machine should be made by competent technicians.

Explanation

Electricity Connection

For main electricity connection plug should be connected to supply line with a 5x4 mm² isolated cable and then plugged into power outlet.

Grounding connection should be made for safety. Machine shouldn't be operated without making grounding connection.

Connection of grounding line

 The following procedures should be followed for this system. Connect one end of the grounding to a copper wire (minimum 16 mm²) as it will enable electrical conductivity. The other end should be either connected with a pipe that has a conductivity capacity immersed into the ground (preferably into a humid ground) or the copper plate should be buried into the ground as much as deep.



Figure 2: Leveling the machine on a solid ground

3. MACHINE RUNNING PROCEDURES ORDER

- Be sure that the machine is assembled in conformance with the Machine Assembly procedures.
- If there is any object on the machine (including the bending apparatus) they must be removed.
- LEFT-RIGHT switch on the control panel of the machine is turned to LEFT or RIGHT position, MAN AUTO switch is turned to MAN position and machine turning direction is confirmed by pressing on the foot pedal.

Explanation: Rotation direction is approved by taking the front of the machine as reference (Control pane side) the clockwise as right and counter-clockwise as left. If the machine is rotating reverse of the switch it means phases of the electricity supply are feeding reversely. This situation doesn't affect the running system of the machine. In such case LEFT-RIGHT switch might be turned to the other side or competent electricians might change the directions of the phases.

After fixing the direction of rotation bending adjustments should start.

Control buttons

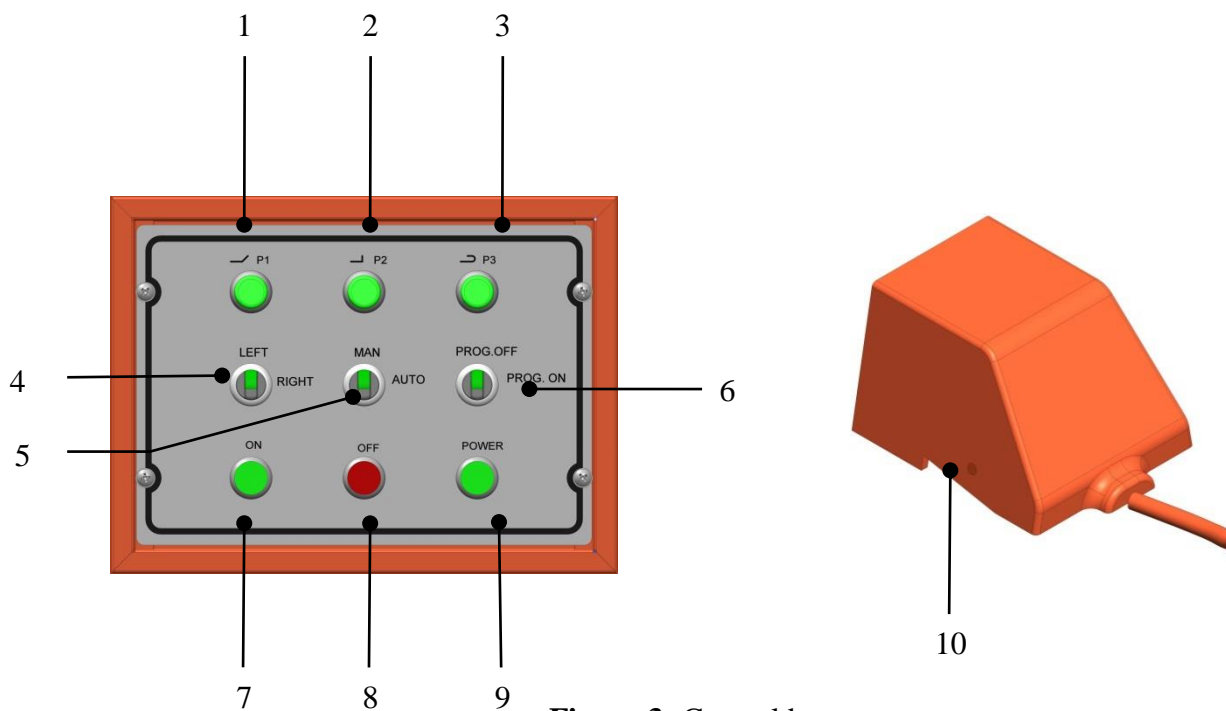

Figure 3: Control buttons

1	P1 Button	6	Program On-Off Switch
2	P2 Button	7	On Button
3	P3 Button	8	Off Button
4	Left-Right Switch	9	Power Button
5	Man-Auto Switch	10	Foot Pedal

4. TECHNICAL DATA

Machine Bending Capacity:

Steel Quality	Diameter/Bending Capacity				
45 kg/mm ²	Ø 36x1	Ø 18x2	Ø14x2	Ø9x4	Ø6x6
65 kg/mm ²	Ø 28x1	Ø 16x2	Ø14x2	Ø9x3	Ø6x4
85 kg/mm ²	Ø 26x1	Ø 12x2	Ø9x2	Ø9x3	Ø4x6
Steel Quality	Diameter/Bending Capacity				
45 kg/mm ²	Ø 36x1	Ø 18x2	Ø14x2	Ø9x4	Ø6x6
65 kg/mm ²	Ø 28x1	Ø 16x2	Ø14x2	Ø9x3	Ø6x4
85 kg/mm ²	Ø 26x1	Ø 12x2	Ø9x2	Ø9x3	Ø4x6

Machine Model: B 36

Machine Name: Mechanical Iron Bending Machine

Machine Dimensions:

Width : 81 Cm
 Length : 92 Cm
 Height: 85 Cm
 Weight : 407 Kg

Specifications of the Motor Used:

Motor power : 3 kW
 Motor RPM : 1400 rpm
 Motor Voltage : 380 V
 Frequency : 50 Hz

5. EQUIPMENT SUPPLIED WITH MACHINE

- Pin: 5 Pieces
- Stirrup Pin : 1 Piece
- Straight Pin : 1 Piece
- Bending Sleeve 5 Pieces
- Adjustment spanner 1 Piece
- SWITCH pin 6 pieces
- Retainer : 1 Piece

6. USING THE MACHINE

6.1 Correct Connection of the Irons on the machine

Fixing the iron to be bent on the machine with the help of retainer (4a)

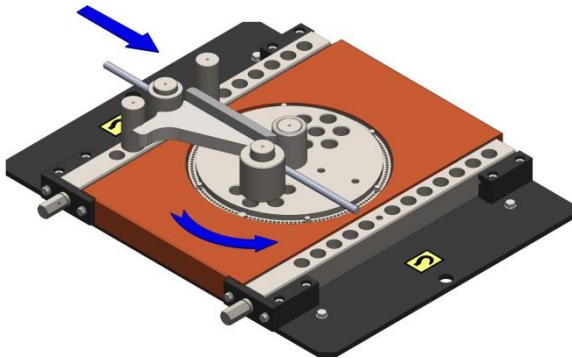

(4a)

Fixing the iron to be bent on the machine with the help of bending sleeves.(4b)

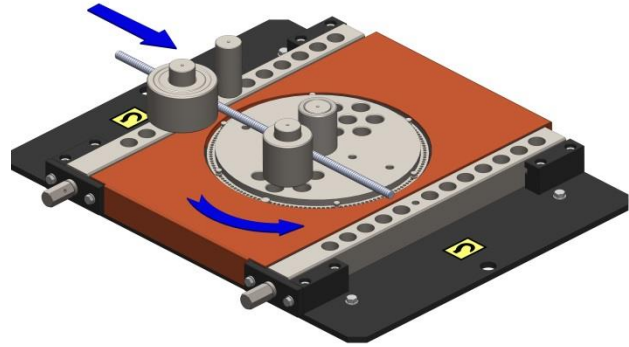

(4b)

Fixing the irons to be bent on the machine with the help of retainer in multi-iron bending (4c)

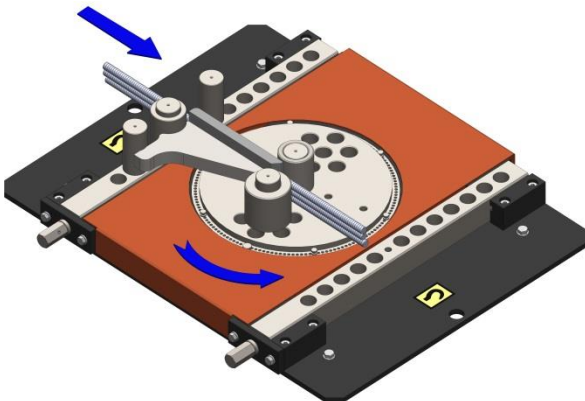

(4c)

Fixing the irons to be bent on the machine with the help of bending sleeves in multi-iron bending (4d)

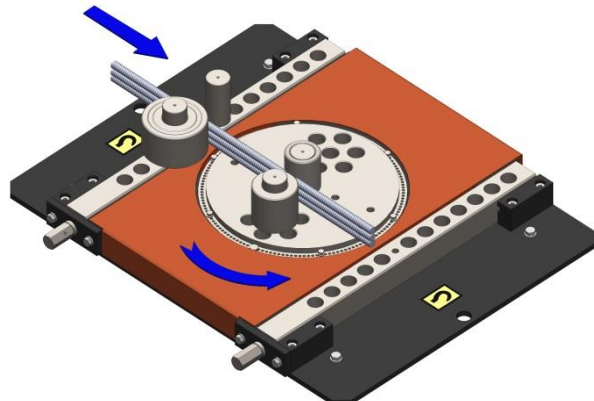

(4d)

Figure 4: Placing the irons on the machine correctly

6.2. Incorrect placement of the irons to be bent on the machine

Incorrect placement of a single iron to be bent with bending sleeves (5a)

Incorrect placement of a single iron to be bent with retainer (5b)

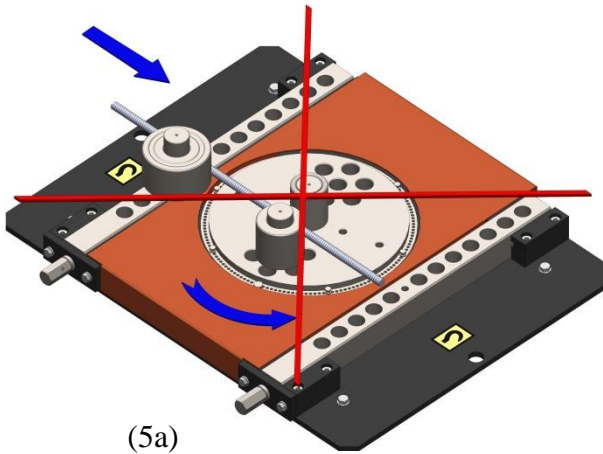

(5a)

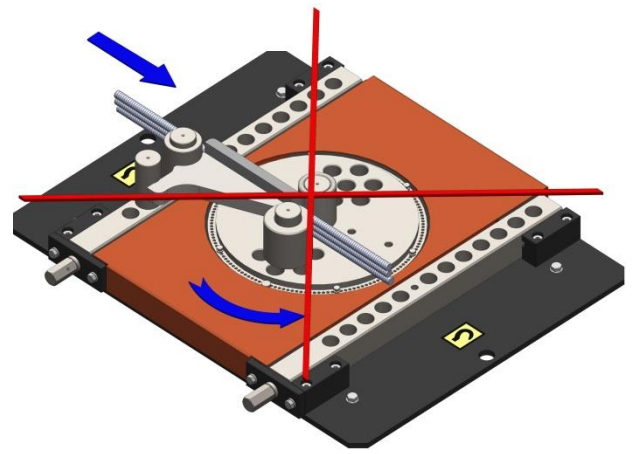

(5b)

Figure 5: Incorrect connection of the irons on the machine

6.3. Incorrect placement of the irons to be bent on the machine

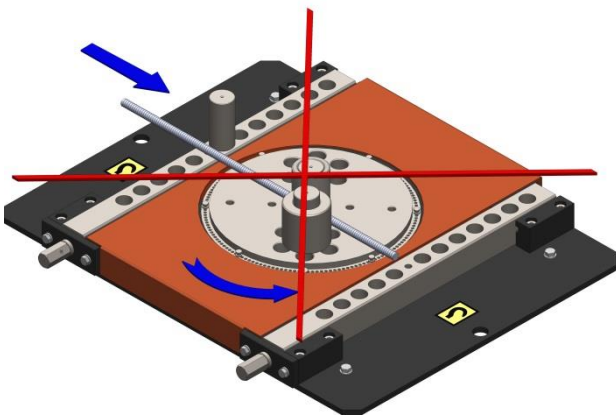

(6a)

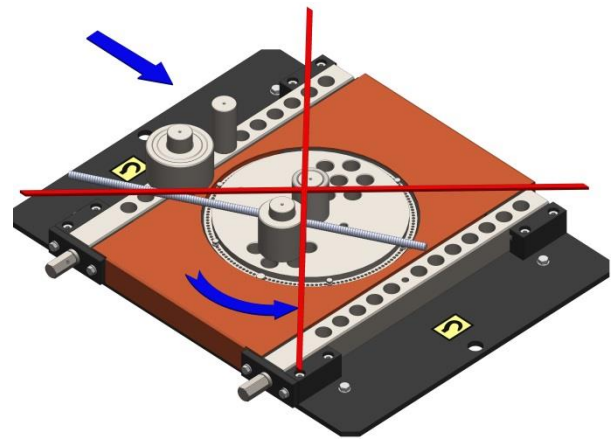

(6b)

Incorrect connection of multi-irons to be bent on the machine with bending sleeves

Incorrect connection of multi-irons to be bent on the machine with retainer

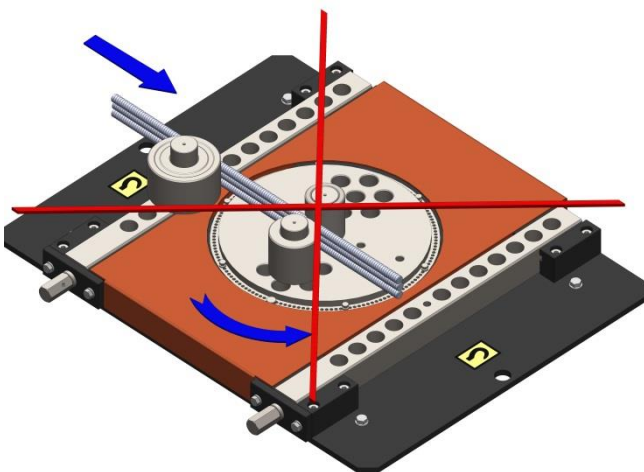

(6c)

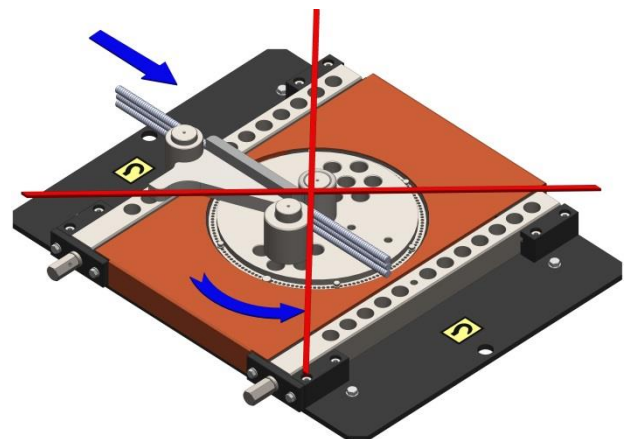

Figure 6: Wrong placement of the irons on the machine



Figure 7: Wrong positioning of the person making bend

7. PROHIBITED USAGE ON THE MACHINE

- When bending no one must stand in front of the machine and any one standing must be taken away. **(Figure 7)**
- While the machine is running no any other construction material such as adze, hammer, meter, caliper etc. should be put between the bending apparatus other than the material that will be bent.
- Machine mustn't be run when it is wet.
- No any bending must be made other than the measurements, dimensions and units stated on the capacity plate **(Figure 1-16)**.
- During the multi bending number of irons stated on the capacity plate should be aligned one on top of the other and should be leaned to the retainer or bending rollers. No any other bending should be made other than this. **(Figure 6c-6d)**
- € Machine mustn't be run when the electricity Board Cap **(Figure 1-2)** is open.
- € Electrical settings made in the factory shouldn't be changed.
- € Machine shouldn't be operated without making grounding connection.
- Machine shouldn't be operated when the housing covers are dismantled.
- Machine should be operated by instructed workers.
- Machine never should be run unlubricated.
- Warning plates attached on the machine mustn't be removed.

- No other parts should be mounted to the machine other than the ones manufactured by Göçmaksan company.
- No bending should be made on the machine with bending apparatus which are deformed, cracked or have an increased hole diameter.
- No wrong bending should be made on the machine. **(Figure 5a-5b-6a-6b-6c-6d)**
- Machine should be cleaned by air.
- € In cases when electricity board cap should be opened, the cap mustn't be opened without cutting the power of the machine from the main switch.
- Irons to be bent should be fixed on the machine correctly. Fixing with retainer bending sleeve and pins **(Figure: 4a-4b-4c-4d)**.

8. SCOPE OF THE WARRANTY

Manufacturer acknowledges warranty and liability provided that complying with the following conditions.

- Protectors found on the machine should be used.
- Warning signs should be taken into account.
- Machine shouldn't be operated without making grounding connection.
- Parts manufactured by Göçmaksan Company should be used in case it is required to replace a broken part.
- Conditions indicated under the safety measures should be taken into account.
- Prohibited usage should be taken into account.
- Machine should be assembled in conformance with the assembly conditions.
- Machine should be handled in conformance with the handling conditions.
- Machine should be used by informed and authorized person.
- Measurements, dimensions and steel quality stated on the capacity plate should be taken into account.
- Machine should be used in conformance with its manufacturing purpose.
- Electricity connection should be made by competent technicians.
- Machine shouldn't be used with any of the parts on it disassembled.
- Motor of the machine shouldn't be changed.
- Maintenance of the machine should be made in conformance with the maintenance conditions.
- No iron higher than the indicated size should be bent with retainer (maximum 16 mm)
- Correct bending should be made with the machine.

9. PROTECTORS TO BE USED WHEN WORKING WITH THE MACHINE

9.1. Protector apparel

- Helmet must be worn.
- Glasses must be worn.
- Boots with steel toe must be put on.
- Gloves must be worn.

The aforementioned protectors will be used. In case of not using these apparels there are risks of injury, cutting and trapping hands.

9.2. Work clothes

Inappropriate clothes against snatch or grip while working with the machine are listed below and in case of not conforming to this list might cause risk of injury.

Long hair, dress with long arms, bracelet, uniform with long skirt, any ornament leaning out.

10. HANDLING THE MACHINE

In order to carry the machine forklift, mobile crane or a hoist should be used. When lifting the machine steel cable, chain or fiber sling should be used. When lifting out of the chest lifting lugs on the machine should be used. During the lifting operations experienced expert staff and subcontractors should be assigned.



WARNING!!!

Machine should be moved without any vibration. Machine shouldn't be run in a wet environment. If there are any lost or damaged parts during the handling, they should be reported to the manufacturer.

- When using the lifting and carrying equipment their maximum loading capacities should be taken into consideration.
- During the lifting equipment's center of gravity should be taken into consideration.



WARNING!!! Warning signs on the carrier equipment should be taken into consideration.



Figure 8: Handling the machine

11. CONTROLS AND SETTINGS ON THE MACHINE

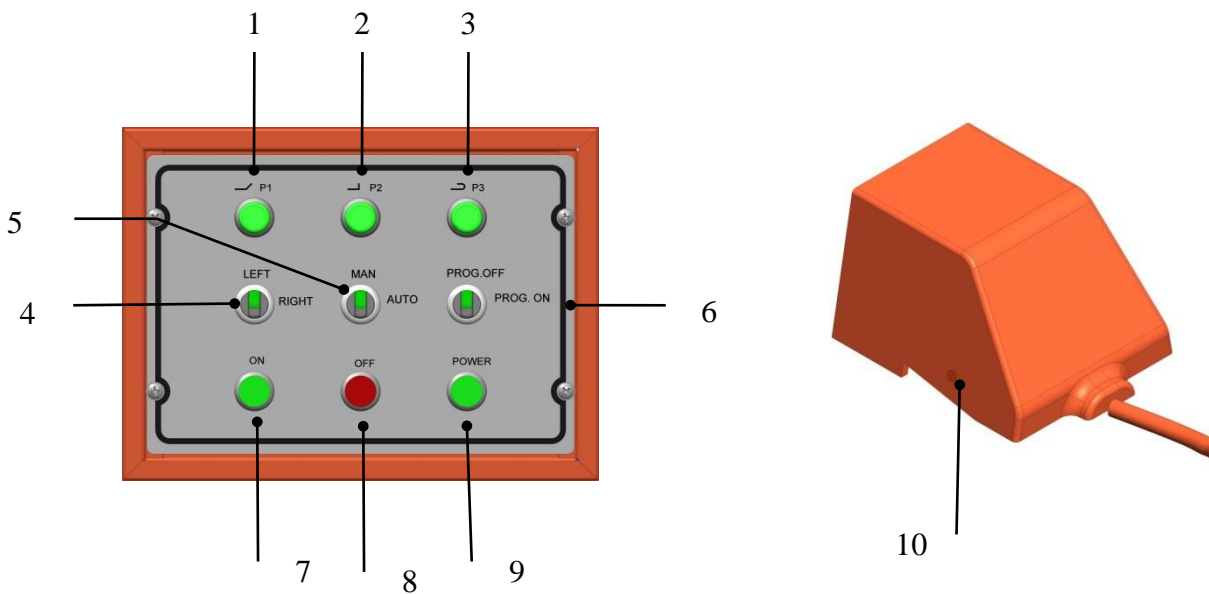

Figure 9: Machine control panel and functions

NO	BUTTON	FUNCTION
1	P1	It ensures settings for bent bar bending

2	P2	It ensures settings for protector bending
3	P3	It ensures settings for hook bending
4	Left-Right	It changes machine's rotation direction to left or right.
5	Man-Auto	It provides machine to be controlled automatically and manually.
6	Program OFF	Machine operates in normal mode. The bending is made according to the preferred angle.
6	Program On	Programming Mode of the Machine
7	ON	It provides machine system to engage.
8	OFF	It ensures switching the machine system off.
9	Power Lamp	It indicates that there is electricity on the system when electricity is supplied to the system when ON button is pressed.
10	Foot Pedal	It ensures rotation of bending flange.

11.1. Thermal flow setting range and motor protection switch

For a motor of 1.5 kW 1440 rpm it is set 5 A by machine manufacturer. It is not appropriate for user to change settings. Motor protection switch is mounted to the machine in order to prevent damage on the system by cutting the electricity current when excessive current is drawn by the system. If the switch is tripped switch should be turned on by turning the button to position 1. Motor protection switch should never be disassembled.

11.2. Bent Bar Bending setting (45°): 
Prog. Off Normal Bending Setting Systems:

Before starting angle setting, it should be ensured that there is no any material on the machine other than the bending equipment.

The Switch button should be taken to OFF position and P1 button should be pressed. There are 3 Switch Pins with same heights on the bending disc. Rotation direction should be controlled by taking the machine to MAN position. Appropriate bending angle for venting should be set by trying the switch pin (P1) (**Figure 1-3**) throughout the holes on the bending disc (A and B directions). As long as the switch pins (A and B) are taken closer to the measurement sensor (**Figure 1-4**) from both sides, the bending angle decreases. Conversely as they are taken away from the measurement sensor the bending angle increases.

NOTE: For P1 button Switch pin=1; For P2 button Switch pin=2; For P3 button Switch pin=3 are used to set the angle.

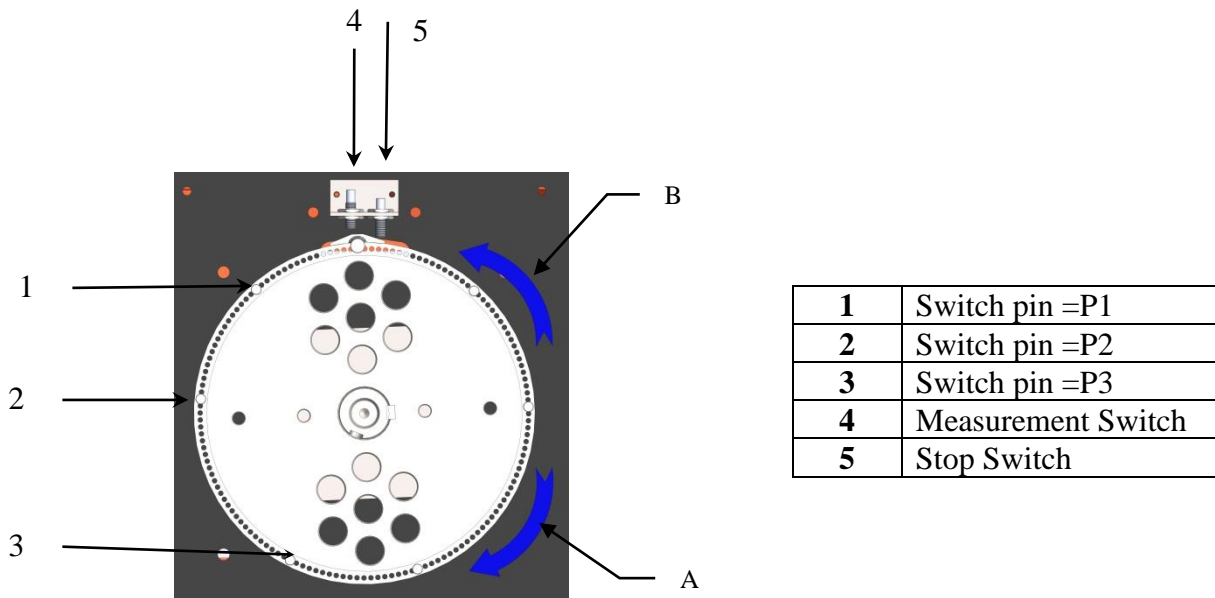

After the setting procedure is completed the iron for bending and bending equipment must be put on the machine and it should be available for bending as it is shown in Figure 4a-4b-4c-4d . It should be mounted according to the diameter (if it is smaller than 16 mm the retainer and if it is bigger than 16 mm the appropriate bending sleeve) of the iron to be bent (**Figures 4a-4b-4c-4d**). Lastly when the bending disc returns after bending the iron it should be mounted on the bending plate on the front side of the iron for safety to prevent any injury due to movement of the iron. (**Figure 10**). Setting process should be completed by ensuring the iron to be bent (**Figures 4a-4b-4c-4d**) positioned parallel by moving bending plates backward and forward with the help of the adjustment spanner. (**Figures 4a-4b-4c-4d**)

For serial bending, machine should be taken to AUTO position and then bending should be made.

NOTE: When the machine is at the MAN position the bending disk revolves, after bending is completed and the machine is on the holding position it stops. When the machine is at the AUTO position bending disk stops at holding position by completing the bending just pressing the Foot Pedal only once. When the machine is at the AUTO position, the machine can be stopped by pressing the

foot pedal as the bending process is started. The stopped machine might be turned to the starting point back manually by continuously pressing the Foot Pedal and it is ensured to be turned to the automatic mode again. Furthermore when the machine is at the AUTO position, Bending Disc might be stopped by holding the Foot Pedal pressed while returning, after the bending process is completed. When the foot pedal is released the machine restarts moving on the direction it stopped and stops at the zero point. The specifications indicated for dangerous cases are used for Emergency stop and it is ensured to protect the operator from the danger.

To change settings, bending process of the machine should be completed (zero point) in the cases where the setting change is required by pressing P1-P2-P3 buttons and then the button required to change the settings should be pressed. Otherwise settings aren't changed when the buttons are pressed.

⚠ WARNING!!! When bending the iron the iron should be bent on bending apparatus with 5 times larger than the diameter of the iron to be bent.

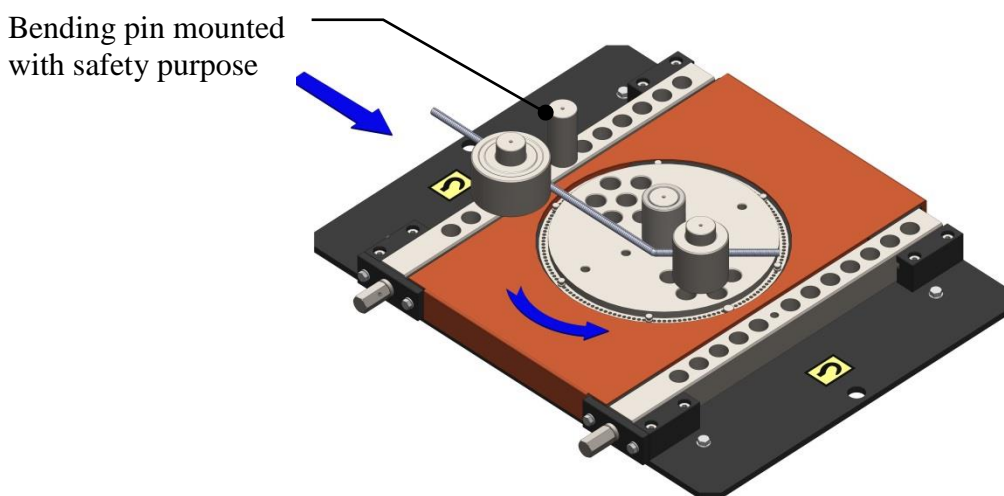

Figure10: Bent bar bending indicator

11.3. Protractor Bending Setting (90°): 

It is set with the same method carried out in bent bar bending by pressing the P2 button on the control panel.

NOTE: The required angle is set for P2 BUTTON by moving the figure:10 switch pin 2 to left and right.

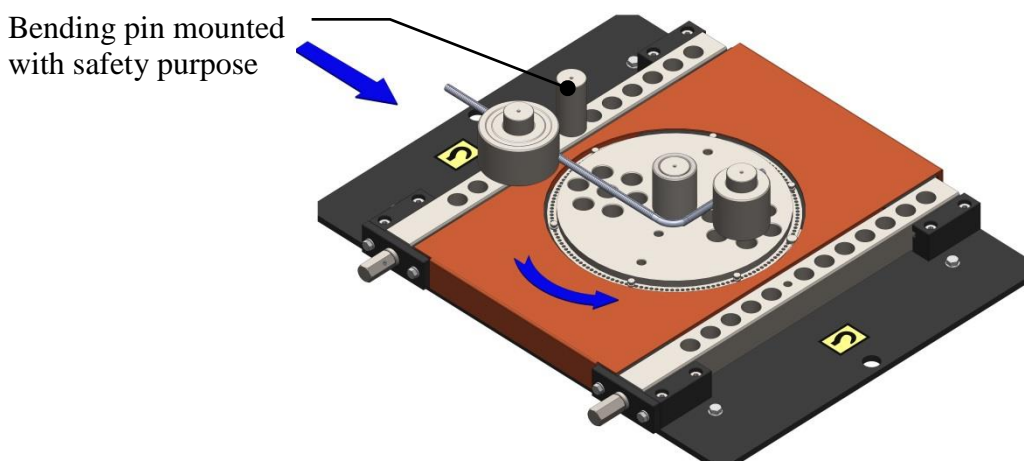

Figure 11: Representation of Protector Bending

11.4. Hook Bending Settings (180°): 

It is set with the same method carried out in bent bar bending by pressing the P3 button on the control panel.

NOTE: The required angle is set for P3 BUTTON by moving the figure: 10 switch pin 3 to left and right.

Bending pin mounted with safety purpose

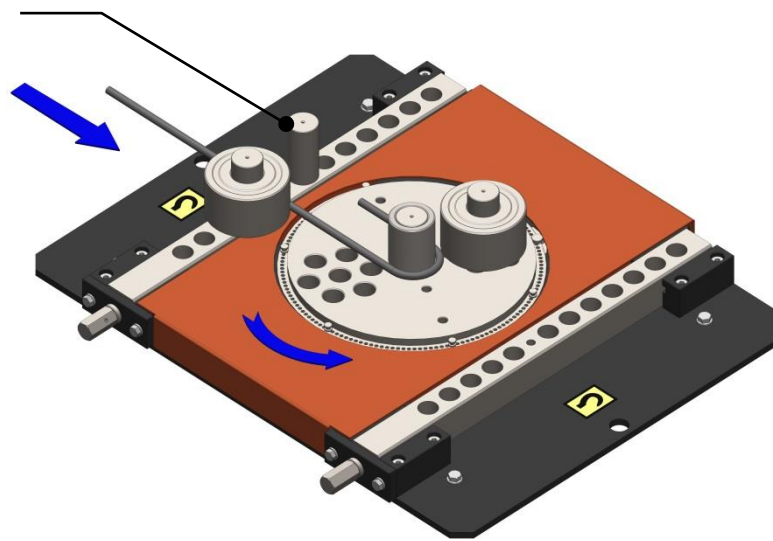

Figure12: Hook Bending demo

**11.5. Stirrup Bending:
Stirrup Bending Mode:**

Prog. On Stirrup Bending Setting Systems:

PROGRAM OFF-ON SWITCH BUTTON should be at program ON position. 90° angle which is used in stirrup bending should be set to P2 button before the program is taken to ON position, the SWITCH BUTTON should be turned to program non position (clockwise) after the stirrup tip bending with 135° are set to P3 button. After turning the SWITCH BUTTON, P1 button should be pressed once. Afterwards P1-P2-P3 buttons will blink only once. This warning indicates that the machine is ready for programming. After this process, programming starts according to the required bending angle. For example: Programming for performing stirrup bending shape is described below.



(Figure 9-



(Figure 9-



(13h)

Programming the described shape:

- a) Press P3 button for once for the 1st angle,
- b) Press P2 button three times successively for 90° bending in 2nd, 3rd and 4th angles.
- c) The programming process for the 5th angle made after pressing P3 button is saved to the memory by pressing the foot pedal and programming process is completed. After the setting procedure is completed (**Figures 13a-13b-13c-13d-13e-13f-13h-13h**) bending order is followed and Stirrup Bending should be completed.

NOTE: When the program ON-OFF SWITCH BUTTON is turned to ON position program is reset and it must be re-programmed. The button should be switched to OFF position as long as it is not needed. In case it is turned, the program should be redone as it is shown in the example.

NOTE: Iron that will be stirred up should be bent on an appropriate Bending Sleeve, Pin, Stir-up pin or straight pin with at least 5 times bigger than the bending iron's diameter.

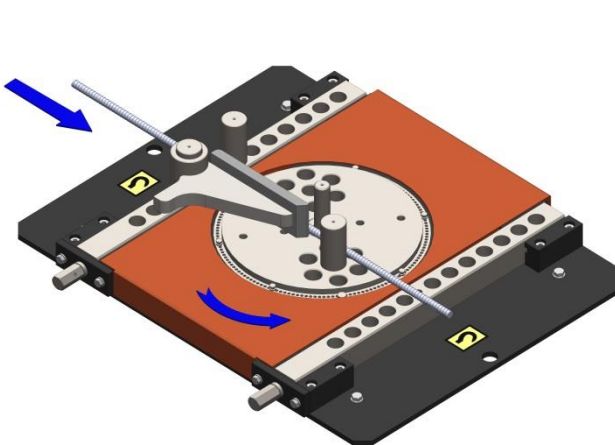

(13a)

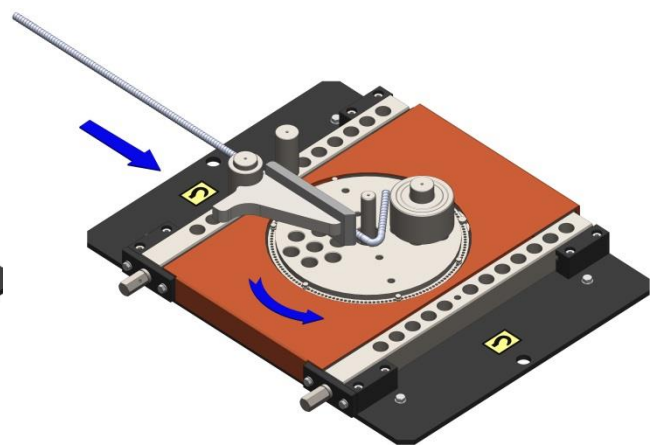

(13b)

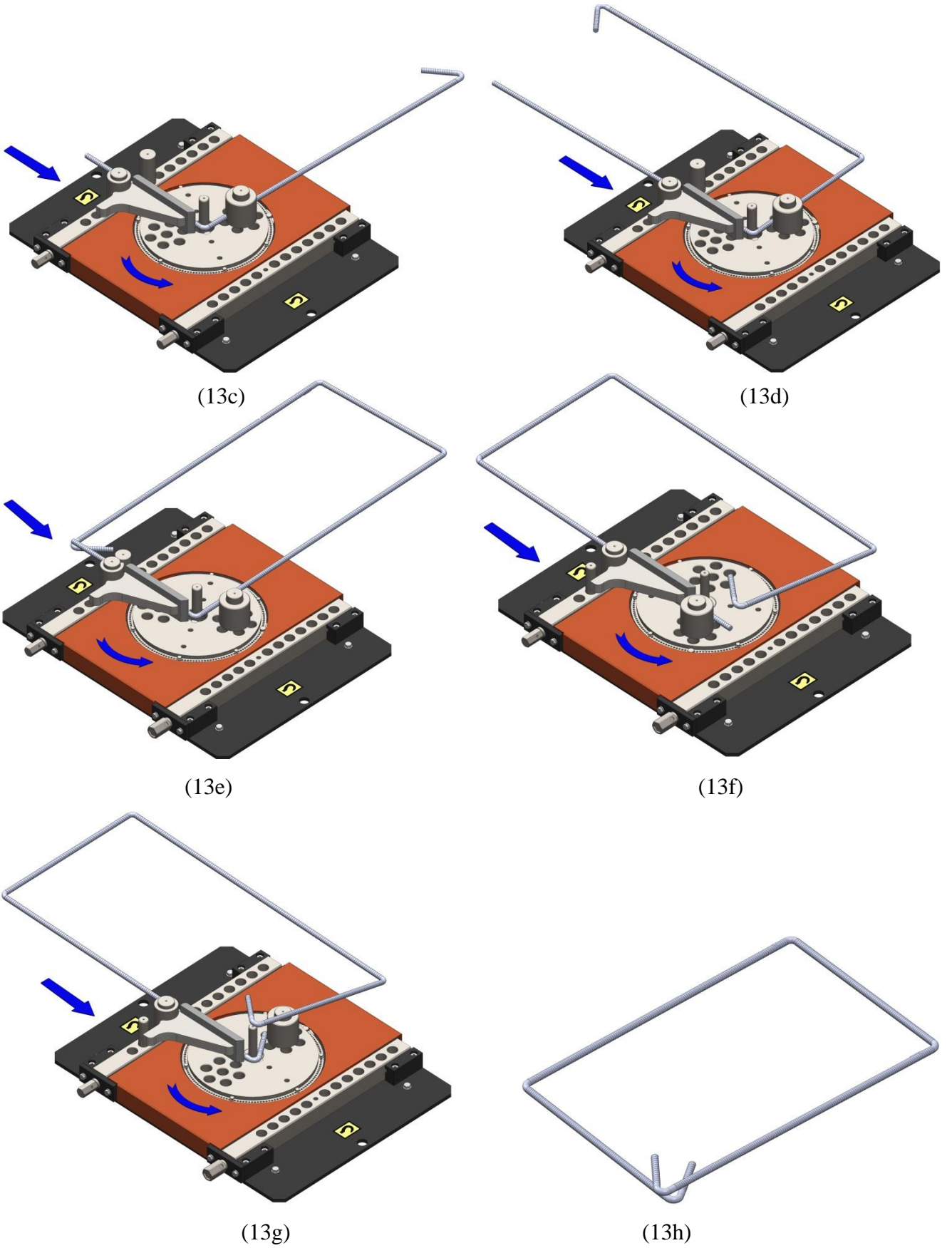

Figure13: Stirrup bending demo



WARNING!!!

In order to fix the faults and determine the electricity malfunction if it is required to open the power panel, power connection of the machine must be turned off and competent technicians should make the maintenance.

12. MAINTENANCE AND LUBRICATION INSTRUCTIONS

It is important to make maintenance correctly in order to extend service life of the machine and to ensure safe bending. We suggest for each user to set up a secure system for control and maintenance of the machine. The following descriptions are given for reference. Number 140 gear oil is used in machine's reducer unit.

Daily maintenance of the machine

- Clean dust and scales on the machine with a brush.
- If the machine is running outdoors it must be protected from rain water when raining.
- Machine should be checked if there is extraordinary voice or not.

Weekly maintenance of the machine

- Parts driving machine bending plates should be cleaned and lubricated.
- Machine adjusting lever mechanism should be cleaned and lubricated.

Monthly maintenance of the machine:

- Bending pins and bending plates should be checked and any cracked or skewed parts mustn't be used.
- Reducer should be checked if there is oil leakage or not.
- Machine's sensor display should be checked if it has dirt on it or not and also the lamp behind it should be checked if it is working or not.

Semi-annual maintenance of the machine:

- All the bolt connections of the machine should be checked.

Annual maintenance of the machine:

- Oil of the machine should be changed.
- If it is out of order seals and bearings should be changed.
- Any skewed, cracked, worn parts should be checked and replaced.

10. FAULTS AND SOLUTION OFFERS

Any faults those might arise when running the machine, and their causes and solutions are given in the table below.

**WARNING!!!**

In order to fix the faults and determine the electricity malfunction if it is required to open the power panel power connection of the machine should be turned off by switching the main switch to 0 positions and competent technicians should make the maintenance.

NO	FAULT	DESCRIPTION	SOLUTION
1.	Machine isn't running:	<ol style="list-style-type: none"> 1. Missing phase might come to the electric supply system where the machine is connected. 2. Emergency stop button might be pressed. 3. Motor protection switch might be blown. 4. LEFT STOP RIGHT switch might be turned off. 5. Electricity Board Cap might be open or haven't been closed completely. 	<ol style="list-style-type: none"> 1. Check the phases. 2. Check the button. If it is pressed open it by turning to the direction of the arrow on the button. 3. Check the motor protection switch. If the switch is blown turn it to the position 1. 4. Check the switch. If it is on stop position turn it to right or left positions. 5. Check the Electricity Board Cap.
2.	Bending disk turning continuously.	<ol style="list-style-type: none"> 1. Sensor might be broken down. 2. There might not be Zero Adjustment Pin and SWITCH pins over the machine flange. 3. Direction contactors might be broken down. 	<ol style="list-style-type: none"> 1. Check whether the sensor is working or not, if it is out of order replace it. 2. Check the pins and if any of them is missing, complete it. 3. Check the contactors.
3.	Motor protection switch is blowing continuously.	<ol style="list-style-type: none"> 1. Diode might be broken. 2. Motor might be blown. 3. If the machine is bending iron over its bending capacity: 4. Missing phase might come to the electric supply system. 5. Transformer might be blown. 6. There might be short circuit or wearing on the cables. 	<ol style="list-style-type: none"> 1. Check the diode. 2. Check the motor. 3. Check the bent iron according to the material type and measurements on the capacity plate. 4. Check the phases on the electricity network. 5. Check the transformer. 6. Check the cable and connections.

<p>4.</p>	<p>Machine is not running although the foot pedal is pressed.</p>	<ol style="list-style-type: none"> 1. The plug might be displaced. 2. Pedal switch might be out of order. 3. Contactors in the electricity network might be out of order. 	<ol style="list-style-type: none"> 1. Check the plug. 2. Check the SWITCH. Change them if they are out of order. 3. Check the contactors.
<p>5.</p>	<p>Emergency Stop is not running.</p>	<ol style="list-style-type: none"> 1. Emergency stop contact might be out of order. 2. Cable Connections might be unplugged. 	<ol style="list-style-type: none"> 1. Change the emergency stop button. 2. Check the cable connections.
<p>6.</p>	<p>Machine is making noise.</p>	<ol style="list-style-type: none"> 1. Bearings might be broken down. 2. Motor's propeller cap might be rubbing. 3. Gears might be broken down. 4. There might be no oil in the reducer. 5. Missing phase might come to the electric supply system which the machine is connected. 6. Machine might have difficulty over its capacity. 7. Brake might not be released or brake lining might scrape after being broken down in the electromagnetic braked machines. 	<ol style="list-style-type: none"> 1. Check the bearings. 2. Check the propeller cap. 3. Check the gears. 4. Check the reducer oil. 5. Check the phases in the network. 6. Check the bent iron according to the capacity plate. 7. Check whether the brakes are running or not and the brake linings.
<p>7.</p>	<p>Machine is leaking oil.</p>	<ol style="list-style-type: none"> 1. Reducer ventilation cap might not be mounted. 2. Motor seal might be leaking oil. 3. Reducer connection bolts might be loose. 	<ol style="list-style-type: none"> 1. Check whether the plug is mounted or not. 2. Check the motor from the propeller side. If there is oil change the motor seal. 3. Check the connection bolts and if loose screw.

14. MACHINE EQUIPMENT LIST

PART NUMBER	DESCRIPTION	PIECE
B36-01	MACHINE BODY	1
B36-02	PLANET PLATE SHEET	1
B36-03	PLANET REDUCER STEM STEEL	1
B36-04	PLANET REDUCER	1
B36-05	ADJUSTMENT SPANNER	1
B36-06	PLATE	1
B36-07	CE LOGO - PLANET	1
B36-08	COVER HINGE	2
B36-09	ELECTRICAL PANEL	1
B36-10	M12 WASHER	4
B36-11	(M12X35 BOLT DIN933	4
B36-12	Ø70 BENDING SLEEVE	2
B36-13	Ø90 BENDING SLEEVE	1
B36-14	Ø110 LUK BENDING SLEEVE	1
B36-15	(Ø130 BENDING SLEEVE	1
B36-16	SWITCH PIN	6
B36-17	START BUTTON	1
B36-18	STOP BUTTON	1
B36-19	POWER LAMP	1
B36-20	GROUNDING TAG	1
B36-21	SENSOR	2
B36-22	ELECTRICAL PANEL CAP	1
B36-23	P1 BENDING BUTTON	1
B36-24	P2 BENDING BUTTON	1
B36-25	P3 BENDING BUTTON	1
B36-26	REAR CONNECTION PLATES	4
B36-27	LEFT CONNECTION PLATE	2
B36-28	M12 SPRING WASHER	16
B36-29	M12X60 BOLT DIN933	16
B36-30	BENDING PLATE ASSEMBLY	2
B36-31	ADJUSTMENT STUD	2
B36-32	FACE CONNECTION PLATE	2
B36-33	M10 SPRING WASHER DIN 1140	4
B36-34	M10x 30 BOLT DIN933	4
B36-35	ADJUSTER NUT	2
B36-36	M8X10 SETSKUR DIN914	1
B36-37	10X16X44 WEDGE	1
B36-38	BENDING FLANGE	1
B36-39	M6X10 BOLT DIN7985	4
B36-40	ZERO ADJUSTMENT PIN	1

B36-41	MEDIUM CASING	1
B36-42	RIGHT MAINTENANCE COVER	1
B36-43	PANEL LOCK	2
B36-44	GÖÇMAKSAN WRITING	1
B36-45	LOWER CASE COVER	1
B36-46	M6X15 COUNTERSUNK BOLT DIN6921	8
B36-47	FOOT PEDAL	1
B36-48	EMERGENCY STOP	2
B36-49	HANDLING TAG	2
B36-50	LEFT-RIGHT SWITCH	1
B36-51	CONTROL PANEL COVER	1
B36-52	BACK MAINTENANCE COVER	1
B36-53	M5X10 BOLT DIN7985	4
B36-54	MAN-AUTO	1
B36-55	CONTROL PANEL	1
B36-56	POWER PLUG	1
B36-57	STIRRUP PIN	1
B36-58	STRAIGHT PIN	1
B36-59	PIN	5
B36-60	RETAINER	1
B36-61	SENSOR NUT	4
B36-62	SENSOR ANGLE	1
B36-63	RIGHT CONNECTION PLATE	2
B36-64	LOCK NUT	2
B36-65	EMERGENCY STOP	2
B36-66	M6X35 COUNTERSUNK BOLT DIN965	8
B36-67	PROG. ON OFF)	1
B36-68	M12X50mm HEXAGON-HEAD BOLT	
B36-69	TOOL BOX FOR PLANET	1

16. MACHINE ELECTRICITY SCHEME

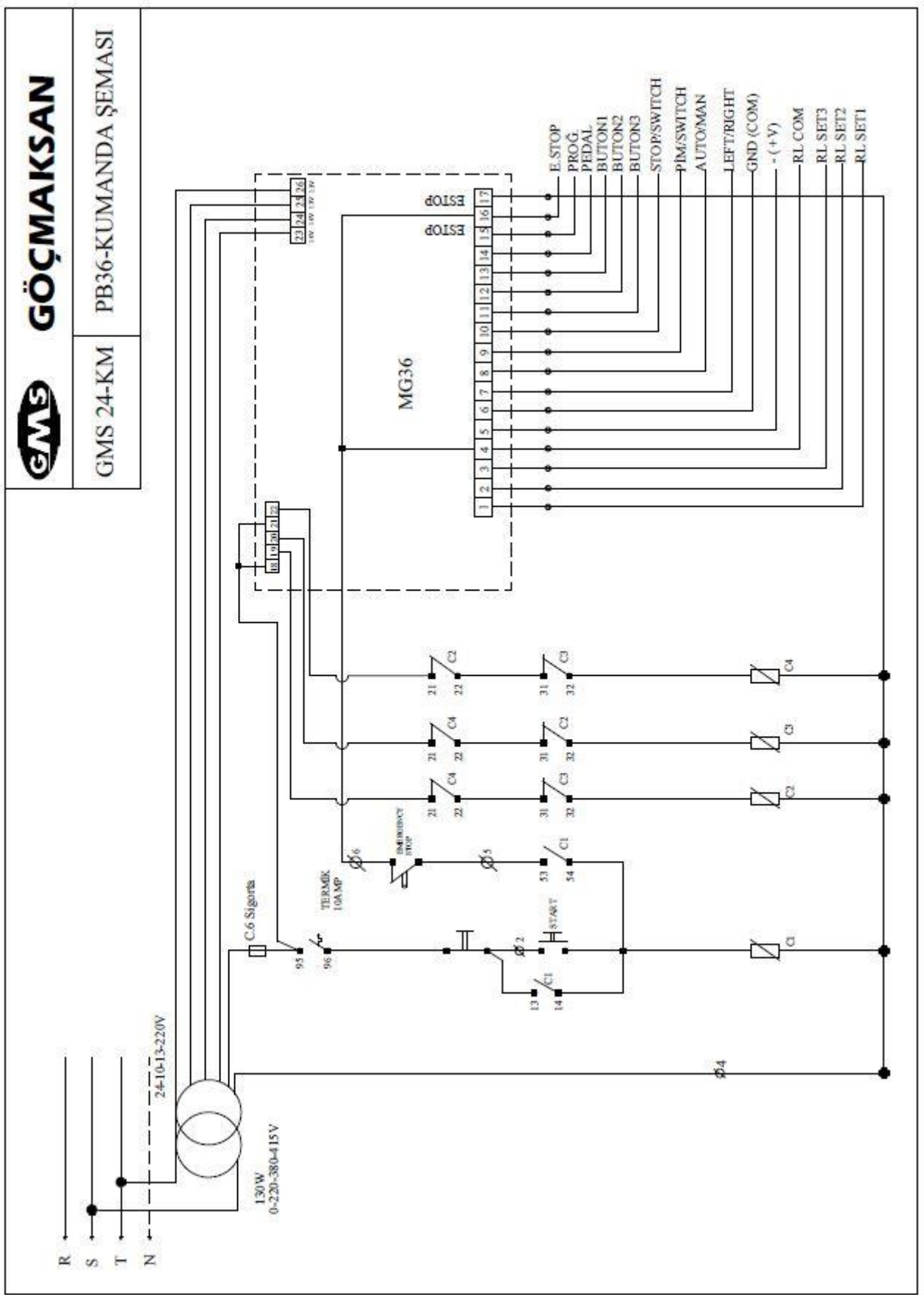

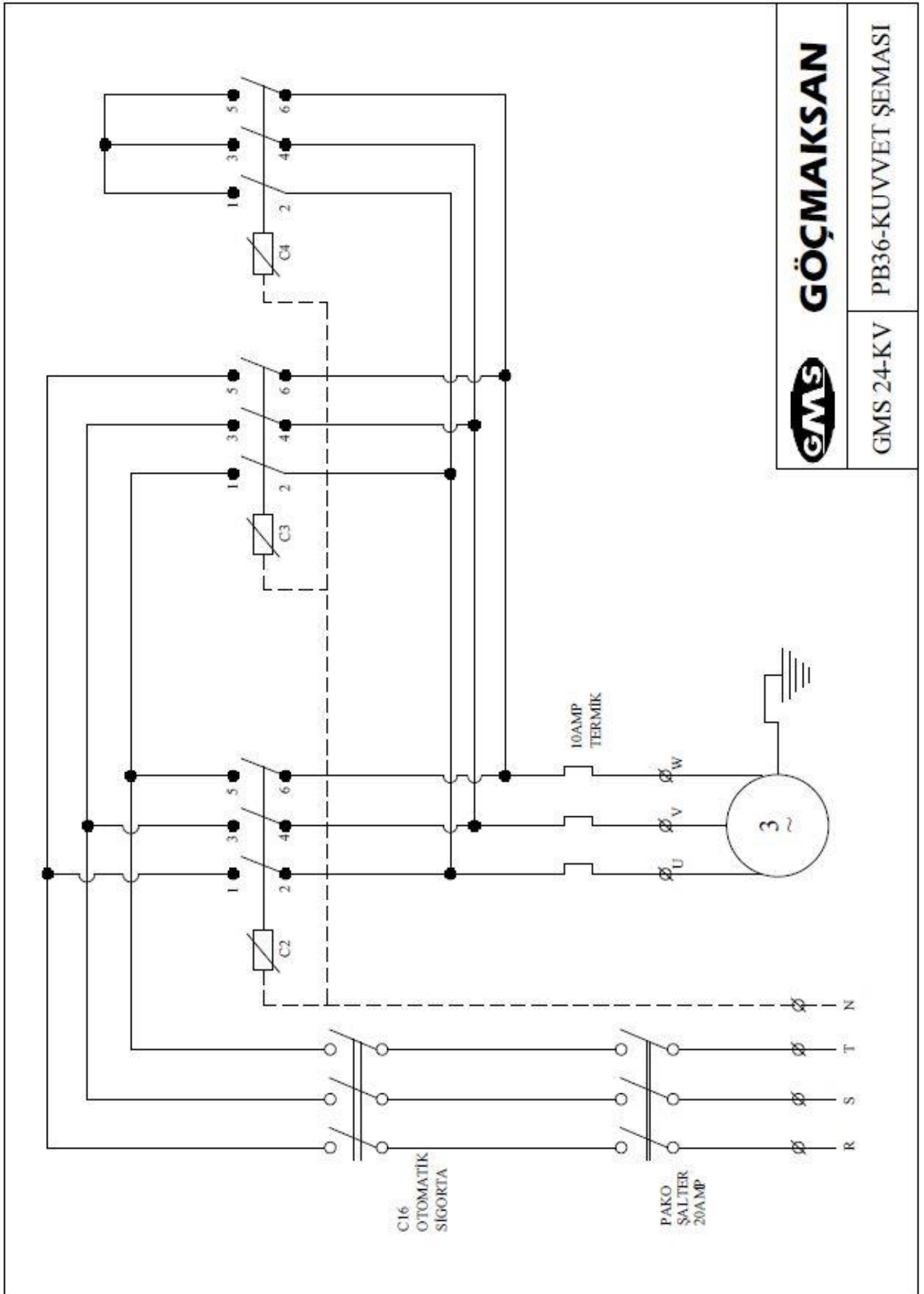

17. ABOUT COMPANY



GÖÇMAKSAN

HAKKIMIZDA | ABOUT US



Göçmaksan 1960 yılından itibaren inşaat sektöründe hizmet vermektedir. İnşaat demiri bükme ve inşaat demiri kesme makineleri çeşitli inşaatçı el aletlerinin üretim, satış, servis, yedek parça ve tasarımını yapmaktadır. Türkiye'de bu alanda ilk olarak üretime başlayan firmamız 45'i aşkın farklı tip ve kapasitede 6mm-60mm arası inşaat demiri kesme ve bükme makineleri üretir hale gelmiştir. Bu başarıya teknolojinin gelişen imkanlarını kullanıp AR-GE çalışmaları ve deneyimli personelleri ile ulaşmıştır. İnşaat sektörünün demir bükme alanında eksik duyulan yönlerini araştırıp bu sorunları çözümlen makina kumanda sistemleri ve redüktörler geliştirip Türk Patent Enstitüsü'nden Faydalı Model ve Endüstriyel Tasarım Tescil belgesini almıştır. Dünyada, inşaat demiri kesme ve bükme makineleri üretimi konusunda lider olmayı amaçlayan firmamız, ISO 9001:2000 kalite sistemi belgeli, TSEK belgeli, GOST-R, Ukr SEPRO belgeli ve 98/37/AT Makine Emniyet yönetmeliğine uygun, CE belgeli olarak makine üretimleri yapmaktadır. Türkiye'de lider ve rakipsiz olan firmamız kaliteli ürünlerini tüm dünyaya ihraç etmektedir.

Göçmaksan Machinery Co. Ltd. serves in construction sector since 1960. Our company manufactures construction steel bending machines, construction steel cutting machines and produces construction hand tools. We provide technical service, maintenance and spare parts as well Göçmaksan is a pioneer in construction sector in Turkey and improves its status with new designs. More than 45 variety of construction steel bending and cutting machines are being produced in our factory which have capacities changing from 6mm to 60mm. Our success comes from our experienced staff, research and development and using high tech facilities. After researching the gaps in bending sector, we developed machine control systems and reducers to provide solution to these gaps and took their Beneficial Model and Industrial Design Registration Certificate from Turkish Patent Institutur. Our company which targets to become a leader ,in producing construction steel cutting and bending machines in the world, is producing proper to ISO 9001:2000 quality system, TSEK, GOST-R, CE, Ukr SEPRO certifications and 98/37/AT machine security regulation. As a leader and rivalled company in Turkey we export our high quality products to whole world.

Merkez/Center
34. Sokak No:5
Ostim - Ankara - TÜRKİYE
Tel : +90 312 354 26 18(pbx)
+90 312 385 79 17 (pbx, 6 lines)
Fax : +90 312 354 40 14